

Electronic pressure switch with display

Model PSD-4

WIKA data sheet PE 81.86



for further approvals,
see page 8



Applications

- Machine tools
- Hydraulics and pneumatics
- Special machine building
- Food and pharmaceutical industry

Special features

- Advanced condition monitoring via IO-Link
- Higher flexibility, lower inventory
- Easy integration combined with good readability
- Fast parameterisation via 3-buttons



Electronic pressure switch, model PSD-4

Description

The PSD-4 electronic pressure switch is the universal solution for industrial automation tasks – also in hygienic applications and under harsh conditions. Due to an accuracy of $< \pm 0.5\%$ and minimal long-term drift, it permanently ensures an accurate representation of the process pressure for more than 100 million load cycles. The pressure switch is available with a digital output signal as well as a switchable and scalable analogue output. In addition, it can also be easily monitored via the self-diagnostics.

Advanced condition monitoring via IO-Link

Condition data and the diagnostic functions allow consistent monitoring. Whether it is defective or whether the pressure or temperature values are above or below the specifications is displayed directly in the system. The data also allow conclusions to be drawn about changing process conditions. Additional information helps to check the loading.

Higher flexibility, lower inventory

Low stocking costs due to fewer variants: With the scalable analogue output, the measuring range can be restricted in a ratio of 5:1. In addition, the output signal can be configured specifically for the application. Thus the PSD-4 can be used flexibly.

Easy integration combined with good readability

Thanks to the large 14-segment display and red digits, pressure values are easy to read, even in bright environments. In addition, the display's content can be turned through 180° and the case through $> 300^\circ$.

Fast parameterisation via 3-buttons

The PSD-4 can be set via 3-button operation. Display and menu offer intuitive navigation in accordance with VDMA specification 24574-1. This speeds up parameterisation and reduces the installation effort.

Specifications

Accuracy specifications	
Accuracy	→ See "Max. measured error per IEC 61298-2"
Max. measured error per IEC 61298-2	≤ ±0.5 % of span
Accuracy of the switch point	≤ ±0.5 % of span
Adjustability of zero point	Max. ±3 % of span
Non-repeatability per IEC 61298-2	≤ 0.1 % of span
Temperature error at 0 ... 80 °C [32 ... 176 °F]	
For all process connections with pressure port	≤ ±1.5 % of span
With increased overpressure limit and process connection G ½ B flush	≤ ±2.5 % of span
For process connections G 1 hygienic and TRI-CLAMP® 1 ½" and 2"	≤ ±3.5 % of span
Long-term drift per IEC 61298-2	≤ ±0.1 % of span
	≤ ±0.2 % of span
	For measuring ranges ≤ 0.6 bar [10 psi], with increased overpressure limit, with process connection G ½ B flush or with process connections G 1 hygienic, TRI-CLAMP® 1 ½" and 2"
Reference conditions	Per IEC 61298-1

Measuring ranges, gauge pressure

bar	
0 ... 0.4 ¹⁾²⁾	0 ... 25
0 ... 0.6 ¹⁾²⁾	0 ... 40 ²⁾
0 ... 1 ¹⁾	0 ... 60 ²⁾
0 ... 1.6 ¹⁾	0 ... 100 ²⁾
0 ... 2.5	0 ... 160 ²⁾
0 ... 4	0 ... 250 ²⁾
0 ... 6	0 ... 400 ²⁾
0 ... 10	0 ... 600 ²⁾
0 ... 16	0 ... 1,000 ^{1) 2)}

1) Not available for process connection G ½ flush.

2) Not available for process connections G 1 hygienic and TRI-CLAMP® 1 ½" and 2".

psi	
0 ... 10 ¹⁾²⁾	0 ... 300
0 ... 15 ¹⁾	0 ... 500 ²⁾
0 ... 25 ¹⁾	0 ... 1,000 ²⁾
0 ... 30 ¹⁾	0 ... 1,500 ²⁾
0 ... 50	0 ... 2,000 ²⁾
0 ... 100	0 ... 3,000 ²⁾
0 ... 160	0 ... 5,000 ²⁾
0 ... 200	0 ... 7,500 ²⁾

1) Not available for process connection G ½ flush.

2) Not available for process connections G 1 hygienic and TRI-CLAMP® 1 ½" and 2".

Measuring ranges, absolute pressure

bar abs.	
0 ... 0.4 ¹⁾²⁾	0 ... 4
0 ... 0.6 ¹⁾²⁾	0 ... 6
0 ... 1 ¹⁾	0 ... 10
0 ... 1.6 ¹⁾	0 ... 16
0 ... 2.5	0 ... 25

1) Not available for process connection G ½ flush.

2) Not available for process connections G 1 hygienic and TRI-CLAMP® 1 ½" and 2".

psi abs.	
0 ... 10 ¹⁾²⁾	0 ... 100
0 ... 15 ¹⁾	0 ... 160
0 ... 25 ¹⁾	0 ... 200
0 ... 30 ¹⁾	0 ... 300
0 ... 50	

1) Not available for process connection G ½ flush.

2) Not available for process connections G 1 hygienic and TRI-CLAMP® 1 ½" and 2".

TRI-CLAMP® is a trademark of the company Alfa Laval AB SE

Vacuum and +/- measuring ranges

bar	
-1 ... 0 ¹⁾	-1 ... +5
-1 ... +0.6 ¹⁾²⁾	-1 ... +9
-1 ... +1.5	-1 ... +15
-1 ... +3	-1 ... +24

- 1) Not available for process connection G ½ flush.
2) Not available for process connections G 1 hygienic and TRI-CLAMP® 1 ½" and 2".

psi	
-14.5 ... 0 ¹⁾	-14.5 ... +100
-14.5 ... +15 ¹⁾²⁾	-14.5 ... +160
-14.5 ... +30	-14.5 ... +200
-14.5 ... +50	-14.5 ... +300

- 1) Not available for process connection G ½ flush.
2) Not available for process connections G 1 hygienic and TRI-CLAMP® 1 ½" and 2".

Special measuring ranges on request.

With special measuring ranges there are deviations in temperature error and long-term drift.

Further details on: Measuring range	
Maximum working pressure	→ Equals the upper range value / full scale value
Overpressure limit	The overpressure limit is based on the sensor element used. Depending on the selected process connection and sealing, restrictions in overpressure limit can result.
Measuring ranges ≤ 600 bar [≤ 7,500 psi]	2 times
Measuring range 1,000 bar [14,500 psi]	1.48 times
Vacuum resistance	Yes
Digital display	
Indication range	14 segments
Units	bar, psi, kg/cm ² , MPa
Colour	Red (LED)
Character size	9 mm [0.35 in]
Digits	4-digit
Display	The display can be rotated electronically through 180°

Increased overpressure limit on request.

With increased overpressure limit there are deviations in temperature error and long-term drift.

Process connection					
Standard	Thread size	Max. measuring range	Overpressure limit	Sealing	
DIN EN ISO 1179-2 (formerly DIN 3852-E)	G ¼ A	600 bar [8,700 psi]	858 bar [12,440 psi]	NBR	
		1,000 bar [14,500 psi]	1,480 bar [21,400 psi]	FPM/FKM	
EN 837	G ¼ B	600 bar [8,700 psi]	858 bar [12,440 psi]	<input type="checkbox"/> NBR <input type="checkbox"/> FPM/FKM	
		1,000 bar [14,500 psi]	1,480 bar [21,400 psi]	<input type="checkbox"/> Without <input type="checkbox"/> Copper <input type="checkbox"/> Stainless steel	
	G ¼ female thread	1,000 bar [14,500 psi]	1,480 bar [21,400 psi]	-	
ANSI/ASME B1.20.1	G ½ B	1,000 bar [14,500 psi]	1,480 bar [21,400 psi]	<input type="checkbox"/> Without <input type="checkbox"/> Copper <input type="checkbox"/> Stainless steel	
		1,000 bar [14,500 psi]	1,480 bar [21,400 psi]	-	
ISO 7	R ¼	600 bar [8,700 psi]	858 bar [12,440 psi]	-	
KS	PT ¼	600 bar [8,700 psi]	858 bar [12,440 psi]	-	
-	G ¼ female (Ermeto compatible)	1,000 bar [14,500 psi]	1,480 bar [21,400 psi]	-	

Process connection						
Standard	Thread size	Max. measuring range		Overpressure limit		Sealing
-	G ½ B flush	600 bar	[8,700 psi]	858 bar	[12,440 psi]	NBR
		400 bar	[5,800 psi]	600 bar	[8,000 psi]	FPM/FKM
-	G 1 hygienic ¹⁾	25 bar	[300 psi]	50 bar	[500 psi]	■ EPDM ■ FPM/FKM
-	TRI-CLAMP® 1 ½"	Depending on the clamp used		Depending on the clamp used		-
-	TRI-CLAMP® 2"	Depending on the clamp used		Depending on the clamp used		-

1) Overpressure limit 1.7 times [272 psi] for gauge pressure measuring range 160 psi

Details must be tested separately in the respective application. The specified values for the overpressure limit serve only as a rough orientation. The values depend on the temperature, the sealing used, the selected torque, the type and the material of the mating thread and the prevailing operating conditions.

Further details on: Process connection	
Max. measuring range	→ See table Process connection page 3/4
Overpressure limit	→ See table Process connection page 3/4
Sealing	→ See table Process connection page 3/4
Pressure port diameter	<ul style="list-style-type: none"> ■ 3.5 mm (standard with all non-flush process connections) ■ 0.6 mm ■ 0.3 mm ■ 10 mm

Output signal

When ordering the PSD-4, only one of the three following output variants has to be selected. The analogue output can be ordered as 4 ... 20 mA output, as DC 0 ... 10 V output or with a switching option between both outputs.

The signal type, as well as the assignment of the second switching output, can be individually set during commissioning. IO-Link is optionally available for all output variants.

Output signal	Switching output 1	Switching output 2	Analogue output	IO-Link option
Output variant 1	x	x	-	x
Output variant 2	x	-	x	x
Output variant 3	x	x	x	x

Further details on: Output signal

Signal type

Switching output 1	<ul style="list-style-type: none"> ■ PNP ■ NPN 	
	Factory setting: PNP	
Switching output 2	<ul style="list-style-type: none"> ■ PNP ■ NPN 	
	Factory setting: PNP	
Analogue output	<ul style="list-style-type: none"> ■ 4 ... 20 mA (3-wire) ■ DC 0 ... 10 V (3-wire) ■ 4 ... 20 mA/DC 0 ... 10 V (3-wire) 	
	Factory setting: 4 ... 20 mA (for version with switching option)	
IO-Link	IO-Link is optionally available for all output signal configurations.	
Switching function	<ul style="list-style-type: none"> ■ Window ■ Hysteresis 	
	Factory setting: Hysteresis	
Contact function	<ul style="list-style-type: none"> ■ Normally open ■ Normally closed 	
	Factory setting: Normally open	
Setting range of the switch points	<ul style="list-style-type: none"> ■ Factory setting ■ Customer-specific 	
	Switch point 1 and switch point 2 are independently settable → See operating instructions	
Switch hysteresis	Minimum 0.25 % of span	
Load		
Analogue signal 4 ... 20 mA	≤ 500 Ω	
Analogue signal DC 0 ... 10 V	> max. output voltage/1 mA	
Signal damping	Configurable from 0 ... 65 s	
Switching delay time	Configurable from 0 ... 65 s	
Reset delay time	Configurable from 0 ... 65 s	
Switching current	Max. 250 mA per switching output	
Switching voltage	Supply voltage - 1 V	
Communication		
IO-Link	Version	Version 1.1
	SIO mode	Yes
	Maximum cycle time	2.3 ms
	Velocity	COM2 (38.4 kBaud)
	Process data width	16 bit (frame type 2.2)
	Support for data management	Yes
	Smart sensor profile	Yes
Voltage supply		
Supply voltage	DC 15 ... 35 V	
Current supply	Max. 600 mA including switching current	
Current consumption	Versions without 4 ... 20 mA output signal	Max. 45 mA
	Versions with 4 ... 20 mA output signal	Max. 70 mA
Overvoltage protection	DC 40 V	
Dynamic behaviour		
Settling time per IEC 61298-2	Analogue signal	≤ 5 ms
	Switching output	≤ 5 ms
Switch-on time	1 s	

Electrical connection	
Connection type	<ul style="list-style-type: none"> ■ Circular connector M12 x 1 (4-pin) ■ Circular connector M12 x 1 (5-pin) ¹⁾
Pin assignment	→ See table pin assignment below
Ingress protection (IP code) per IEC 60529 ²⁾	IP65 and IP67
Short-circuit resistance	S+ / SP1 / SP2 vs. U-
Reverse polarity protection	U+ vs. U-
Insulation voltage	DC 500 V

1) Only for version with two switching outputs and additional analogue signal.

2) The stated IP codes (per IEC 60529) only apply when plugged in using mating connectors that have the appropriate IP code.

Pin assignment

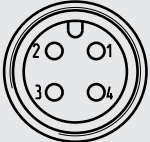
Circular connector M12 x 1 (4-pin)		
	U+	1
	U-	3
	S+	2
	SP1/C ¹⁾	4
	SP2	2

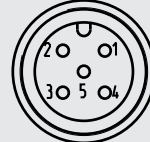
Circular connector M12 x 1 (5-pin)		
	U+	1
	U-	3
	S+	5
	SP1/C	4
	SP2	2

1) Depending on the configuration of the output signals

Legend:

U+	Positive power supply terminal
U-	Negative power supply terminal
SP1	Switching output 1
SP2	Switching output 2
S+	Analogue output
C	Communication with IO-Link

Material		
Material (wetted)		
Measuring ranges < 10 bar [150 psi]	Stainless steel 316L	
	Stainless steel 1.4435/316L with G 1 hygienic and TRI-CLAMP® 1 ½" and 2" process connections	
Measuring ranges ≥ 10 bar [150 psi]	Stainless steel 316L, PH grade steel	
	Stainless steel 1.4435/316L with G 1 hygienic and TRI-CLAMP® 1 ½" and 2" process connections	
Material (in contact with the environment)		
Case	Stainless steel 304	
Keyboard	TPE-E	
Display window	PC	
Display head	PC + ABS blend	
Pressure transmission medium		
For all gauge pressure measuring ranges < 10 bar [150 psi] ¹⁾ , all absolute pressure measuring ranges and G ½ flush	Synthetic oil	
With G 1 hygienic and TRI-CLAMP® 1 ½" and 2" process connections	KN92 medicinal white mineral oil, FDA-compliant per CFR 172.878 and 21 CFR 178.3620(a); conform to USP, EP and JP	
Surface roughness of wetted parts	Process connection G 1 hygienic	Ra ≤ 0.8 µm (except for weld seam)
	Process connection TRI-CLAMP® 1 ½" and 2"	Ra ≤ 0.76 µm per ASME BPE SF3 (except for weld seam)

Material		
Options for specific media		
Oil- and grease-free	Residual hydrocarbon	< 1,000 mg/m ²
Oxygen, oil- and grease-free	Residual hydrocarbon	< 200 mg/m ²
	Packaging	Protection cap on the process connection
	Max. permissible temperature	-20 ... +60 °C [-4 ... +140 °F]
	Available measuring ranges	<ul style="list-style-type: none"> ■ 0 ... 400 mbar to 0 ... 400 bar [0 ... 10 to 0 ... 5,000 psi] ■ -1 ... 0 to -1 ... 24 bar [-14.5 ... 0 to -14.5 ... 300 psi]
	Sealing	Factory supplied without sealing
→ Not available with process connections per ISO 1179-2, G ½ B flush, G 1 hygienic and TRI-CLAMP® 1 ½" and 2"		





1) < 16 bar [250 psi] with increased overpressure limit

Operating conditions		
Medium temperature limit		
Process connections with pressure port and G ½ B flush	-20 ... +85 °C [-4 ... +185 °F]	
Process connection G 1 hygienic	<ul style="list-style-type: none"> ■ -20 ... +100 °C [-4 ... +212 °F] (+135 °C [+275 °F] max. 1h) ■ -20 ... +125 °C [-4 ... +257 °F] (+150 °C [+302 °F] max. 1h) (option) 	
Process connections TRI-CLAMP® 1 ½" and 2"	-20 ... +100 °C [-4 ... +212 °F] (+135 °C [+275 °F] max. 1h)	
Ambient temperature limit	-20 ... +80 °C [-4 ... +176 °F]	
Storage temperature limit	-20 ... +70 °C [-4 ... +158 °F]	
Vibration resistance per IEC 60068-2-6	20 g, 10 ... 2,000 Hz (under resonance)	
	10 g, 10 ... 2,000 Hz (under resonance)	For process connections G 1 hygienic and TRI-CLAMP® 1 ½" and 2"
Shock resistance per IEC 60068-2-27	50 g, 6 ms (mechanical)	
Service life		
Switching cycles	100 million	
Load cycle (mechanical) ¹⁾	100 million or 10 million for measuring ranges > 600 bar [7.500 psi]	

1) Not valid for G 1 hygienic and TRI-CLAMP® 1 ½" and 2"



Packaging and instrument labelling	
Packaging	Individual packaging
Instrument labelling	<ul style="list-style-type: none"> ■ WIKA product label, glued ■ Customer-specific product label on request

Approvals

Logo	Description	Region
	EU declaration of conformity	European Union
	EMC directive EN 61326 emission (group 1, class B) and immunity (industrial application)	
	Pressure equipment directive	
	RoHS directive	
	UKCA	United Kingdom
	Electromagnetic compatibility regulations	
	Pressure equipment (safety) regulations Restriction of hazardous substances (RoHS) regulations	
	EAC EMC directive	Eurasian Economic Community
	UL ¹⁾ Safety (e.g. electr. safety, overpressure, ...)	USA and Canada

1) Not for hygienic connections

Optional approvals

Logo	Description	Region
	PAC Kazakhstan ¹⁾ Metrology, measurement technology	Kazakhstan
-	PAC Ukraine ¹⁾ Metrology, measurement technology	Ukraine
-	CRN Safety (e.g. electr. safety, overpressure, ...)	Canada
	3-A ²⁾ Sanitary Standard This instrument is 3-A marked, based on a third party verification for conformance to the 3-A standard 74-07 (sensors and sensor fittings and connections).	USA
	EHEDG ^{2) 3)} Hygienic Equipment Design EL class I, components for closed processes, cleaning with liquid: Cleaning in place (CIP) without dismounting	European Community

1) Not available with process connections G 1 hygienic and TRI-CLAMP® 1 ½" and 2"

2) For process connection G 1 hygienic

3) For process connections TRI-CLAMP® 1 ½" and 2".

Manufacturer's information and certificates

Logo	Description
-	China RoHS directive
-	MTTF:> 100 years
-	Manufacturer's statement ADI Frei (restricted choice of versions)
-	Manufacturer's declaration of food contact materials in accordance with regulation (EC) no. 1935/2004 and regulation (EC) no. 2023/2006 on good manufacturing practice for materials and articles intended to come into contact with food

Test report

Test report ¹⁾	
Number of measuring points	3
Configurations switching output	<ul style="list-style-type: none"> ■ Switching function ■ Contact function ■ Switch point ■ Reset point

1) Not available with process connections G 1 hygienic and TRI-CLAMP® 1 ½" and 2"

Certificates (option)

Certificates	
Certificates	<ul style="list-style-type: none"> ■ 2.2 test report per EN 10204 (technical version "oxygen service") ■ 3.1 inspection certificate per EN 10204 (e.g. confirmation of the class and indication accuracy, list of single measured values) ■ Material proof for wetted metal parts ■ FDA conformity of the system fill fluid ■ Confirmation of 3-A conformity ■ Confirmation of EHEDG certification ■ Confirmation of surface roughness

→ For approvals and certificates, see website

Dimensions in mm [in]

Pressure switch with circular connector M12 x 1 (4-pin and 5-pin)

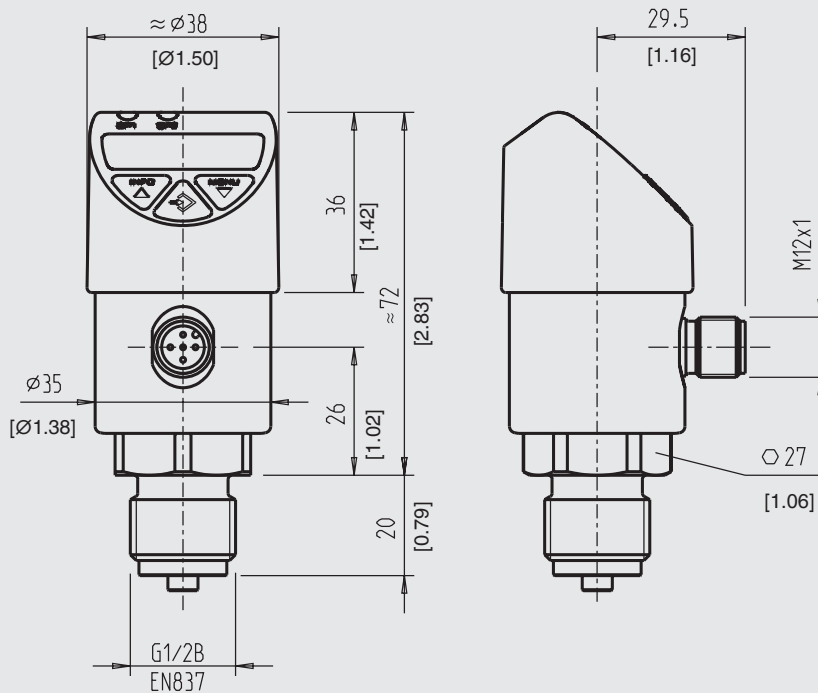

Weight: approx. 220 g [7.76 oz]

Process connections

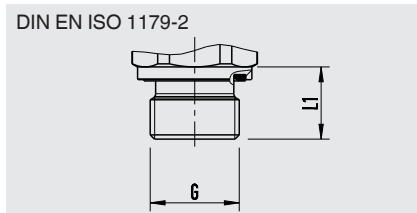

G	L1
G ¼ A	14 [0.55]
G ½ A	17 [0.67]

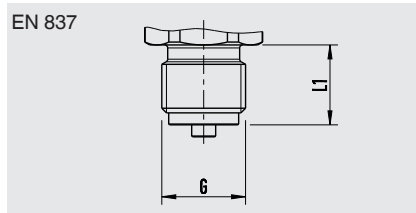

G	L1
G ¼ B	13 [0.51]
G ½ B	20 [0.79]

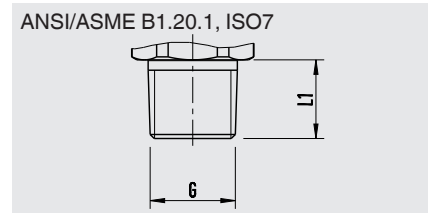

G	L1
¼ NPT	13 [0.51]
½ NPT	19 [0.75]
R ¼	13 [0.51]
PT ¼	13 [0.51]

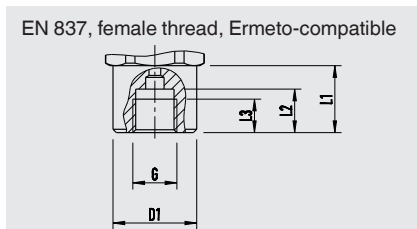

G	L1	L2	L3	D1
G ¼ ¹⁾	20 [0.79]	15 [0.59]	12 [0.47]	∅ 25 [0.98]

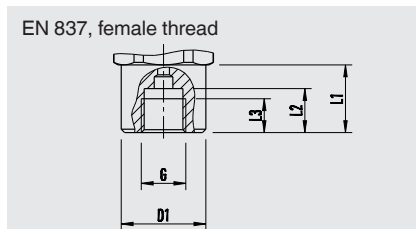

G	L1	L2	L3	D1
G ¼	20 [0.79]	13 [0.51]	10 [0.39]	∅ 25 [0.98]

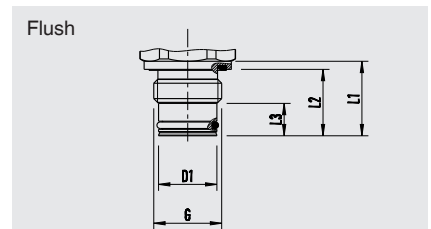

G	L1	L2	L3	D1
G ½ B ²⁾	23 [0.91]	20.5 [0.81]	10 [0.39]	∅ 18 [0.71]

- 1) Ermeto-compatible
2) Welding sockets recommended as defined counter-thread (→ see accessories)

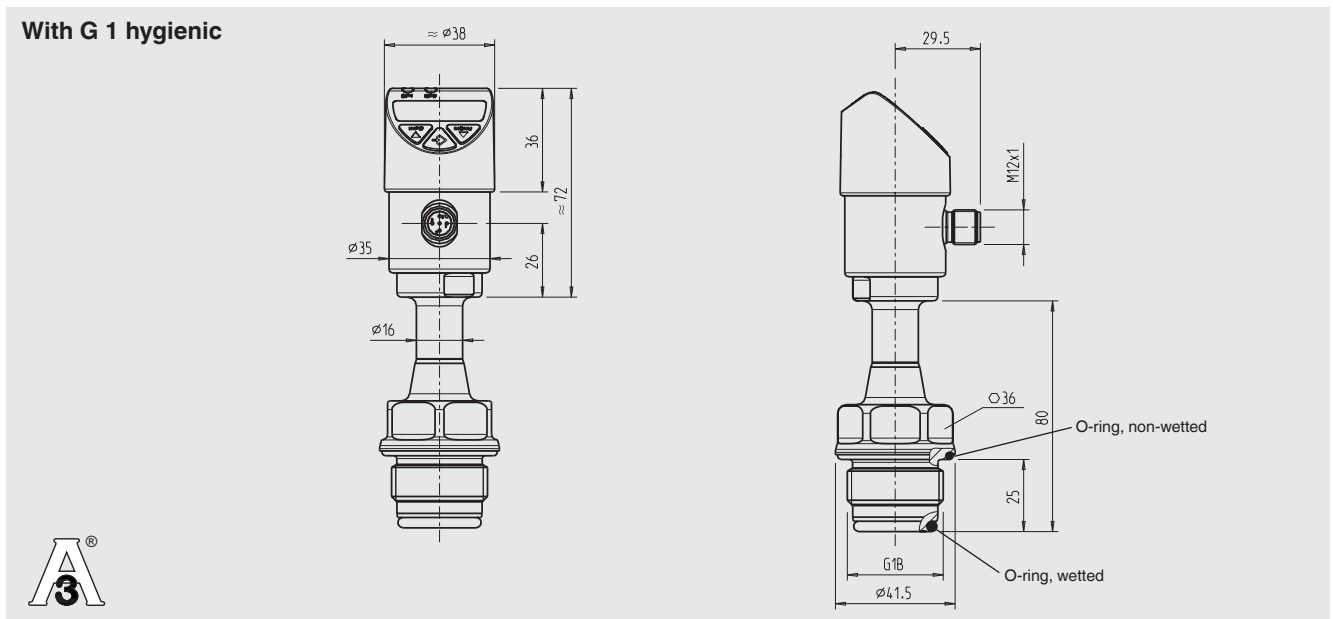

Wetted seals from EPDM or FKM

→ Suitable for WIKA adapter system model 910.61; see WIKA data sheet AC 09.20

→ For dimensions of the appropriate process adapters and welding sockets, see WIKA data sheet AC 09.20

With TRI-CLAMP®

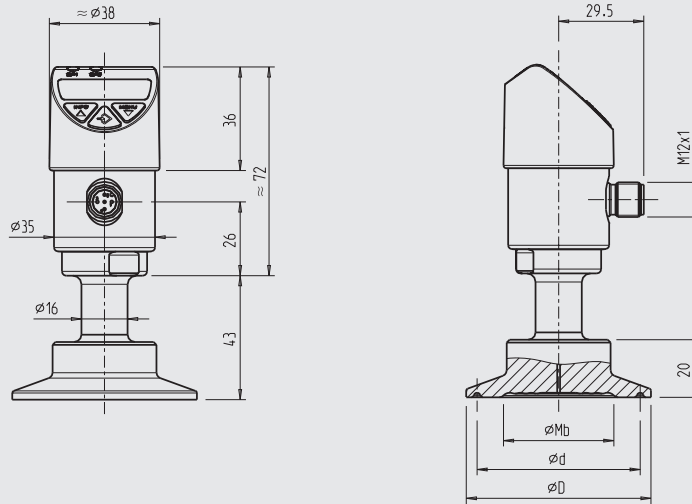

Version		Dimensions in mm		
		Ø Mb	Ø d	Ø D
TRI-CLAMP® 2)	1 ½" per ASME BPE 1 ½", DIN 32676 row A DN 40, row C DN 1 ½", BS 4825 part 3 DN 38.1	32	43.5	50.5
	2" per ASME BPE 2", DIN 32676 row A DN 50, row B DN 42.4 and 48.3, row C DN 2", BS 4825 part 3 DN 50.8	40	56.6	64

- 1) EHEDG conformity only in combination with a T-ring seal from Combifit Metaalbewerking B.V.
 2) For maximum pressure range consider pressure rating of clamp.

→ For further information, see WIKA data sheet DS 99.41



Other process connections on request.

Spare parts



Sealings

Model			Order number	
	Sealings			
	G ¼ A DIN EN ISO 1179-2	NBR		1537857
		FPM/FKM		1576534
		FPM/FKM (for measuring range 0 ... 1,000 bar)		14045531
	G ½ A DIN EN ISO 1179-2	NBR		1039067
		FPM/FKM		1039075
	G ¼ B EN 837	Copper		11250810
		Stainless steel		11250844
	G ½ B EN 837	Copper		11250861
		Stainless steel		11251042
	Sealings for G 1 hygienic, wetted			
	Conformity per FDA 21 CFR 177.2600, USP XXV class VI and 3-A (18-03) Sanitary Standards class 2 (max. 8 % milk fat)		EPDM 70	14004173
Conformity per FDA 21 CFR 177.2600, USP XXIII class VI and 3-A (18-03) Sanitary Standards class 1		FKM 75	14004174	
Sealings for G 1 hygienic, non-wetted		EPDM 70	14023833	

Accessories

Model	Description	Description	Order number
	Welding socket for process connection G 1/2 B flush	G 1/2 B female, outer diameter 50 mm [2 in], material 1.4571	1192299
	Cooling element for screwing G 1/2 female / G 1/2 male per EN 837 (for instruments with process connection G 1/2 B per EN 837)	Max. medium temperature 150 °C [302 °F] at an ambient temperature of max. 30 °C [86 °F] Max. operating pressure 600 bar [8,700 psi]	14109813
		Max. medium temperature 200 °C [392 °F] at an ambient temperature of max. 30 °C [86 °F] Max. operating pressure 600 bar [8,700 psi]	14109815
	Instrument mounting bracket	Instrument mounting bracket for PSD-4, aluminium, wall mounting	11467887

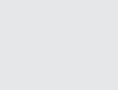
Circular connector M12 x 1 with moulded cable

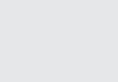
Model	Description	Material	IP code	Temperature limit	Cable diameter	Cable length	Order number
	Straight version, cut to length, 4-pin, UL listed	PUR	IP67	-20 ... +80 °C [-4 ... 176 °F]	4.5 mm [0.18 in]	2 m [6.6 ft]	14086880
						5 m [16.4 ft]	14086883
						10 m [32.8 ft]	14086884
	Straight version, cut to length, 5-pin, UL listed	PUR	IP67	-20 ... +80 °C [-4 ... 176 °F]	5.5 mm [0.22 in]	2 m [6.6 ft]	14086886
						5 m [16.4 ft]	14086887
						10 m [32.8 ft]	14086888
	Angled version, cut to length, 4-pin, UL listed	PUR	IP67	-20 ... +80 °C [-4 ... 176 °F]	4.5 mm [0.18 in]	2 m [6.6 ft]	14086889
						5 m [16.4 ft]	14086891
						10 m [32.8 ft]	14086892
	Angled version, cut to length, 5-pin, UL listed	PUR	IP67	-20 ... +80 °C [-4 ... 176 °F]	5.5 mm [0.22 in]	2 m [6.6 ft]	14086893
						5 m [16.4 ft]	14086894
						10 m [32.8 ft]	14086896

Only use the accessories and spare parts listed, otherwise it could lead to the loss of the UL approval.

Ordering information

Model / Output signal / IO-Link / Measuring range / Process connection / Sealing / Medium / Certificates / Approvals

© 08/2017 WIKA Alexander Wiegand SE & Co. KG, all rights reserved.
The specifications given in this document represent the state of engineering at the time of publishing.
We reserve the right to make modifications to the specifications and materials.

